

Innenansicht

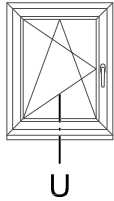

Alublend Elegance

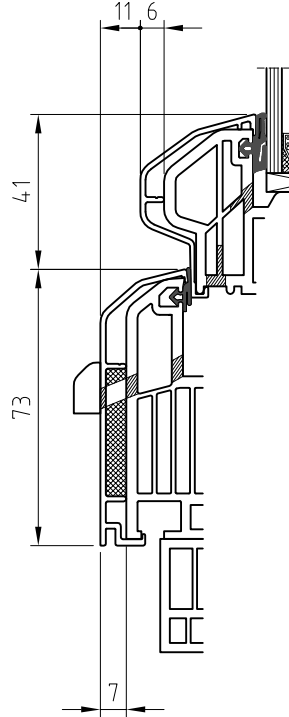

Stock 70 / Flügel 70

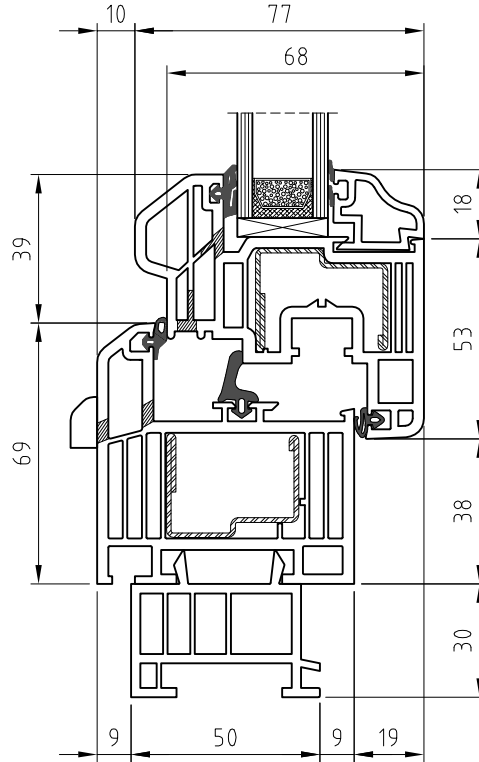

Alublend Elegance

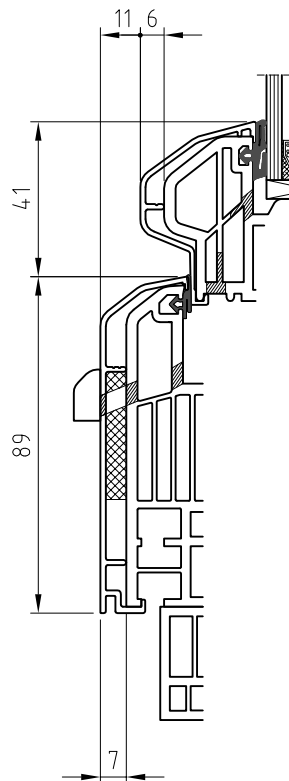

Stock 85 / Flügel 70

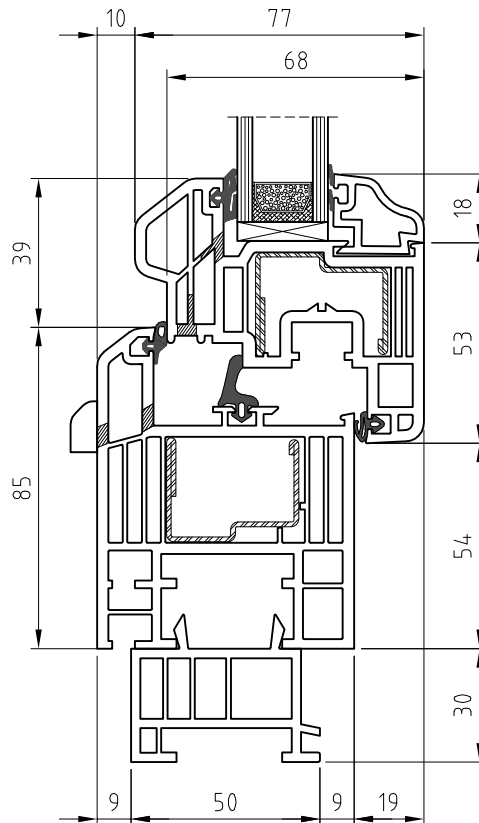

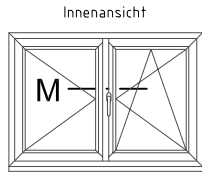
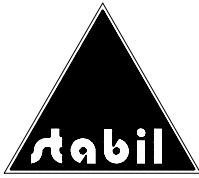

Alublend Elegance

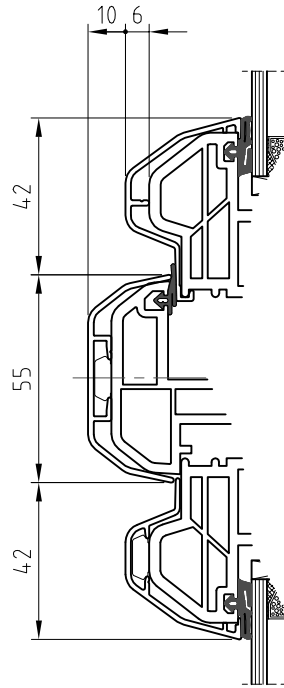

Stulpkämpfer / Flügel 70

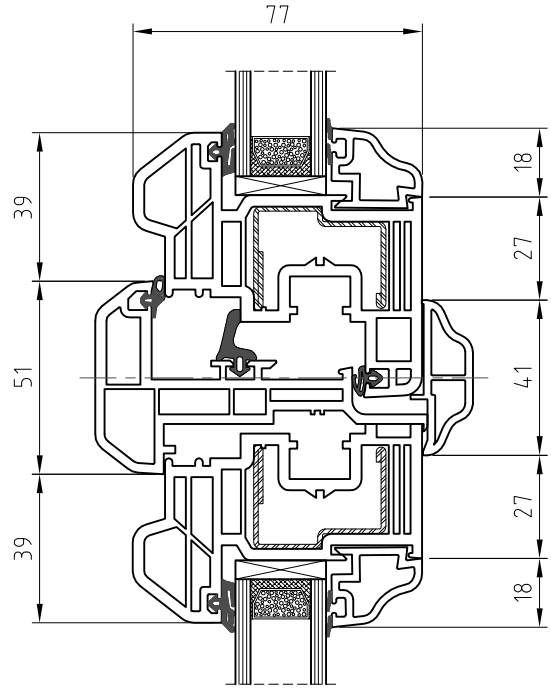

Alublend Elegance

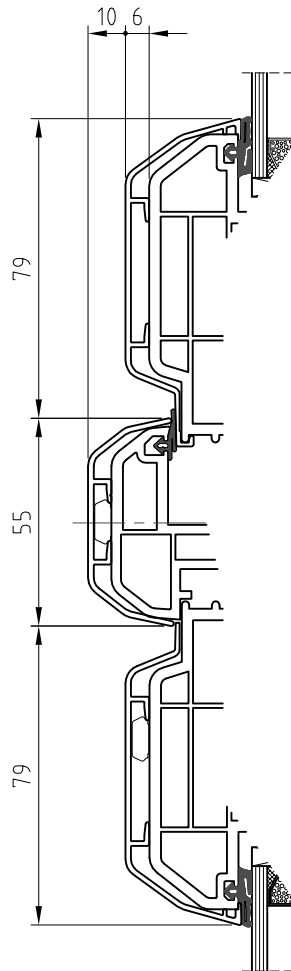

Stulpkämpfer / Flügel 100

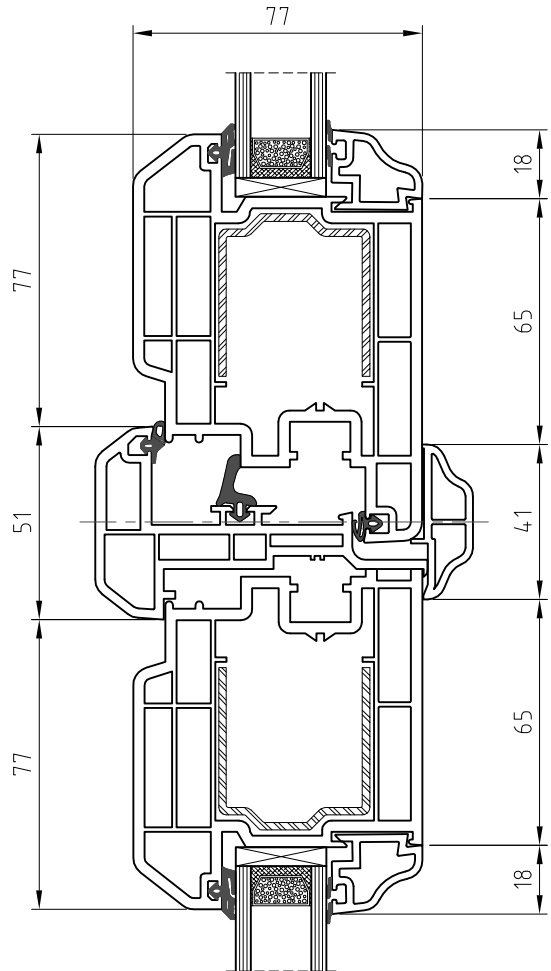

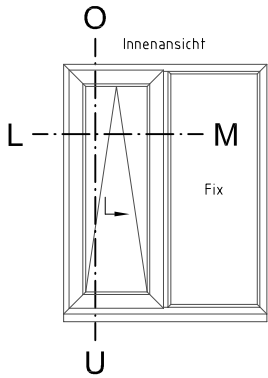
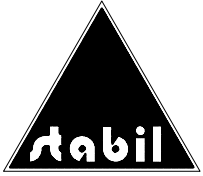

Schnitt senkrecht O-U

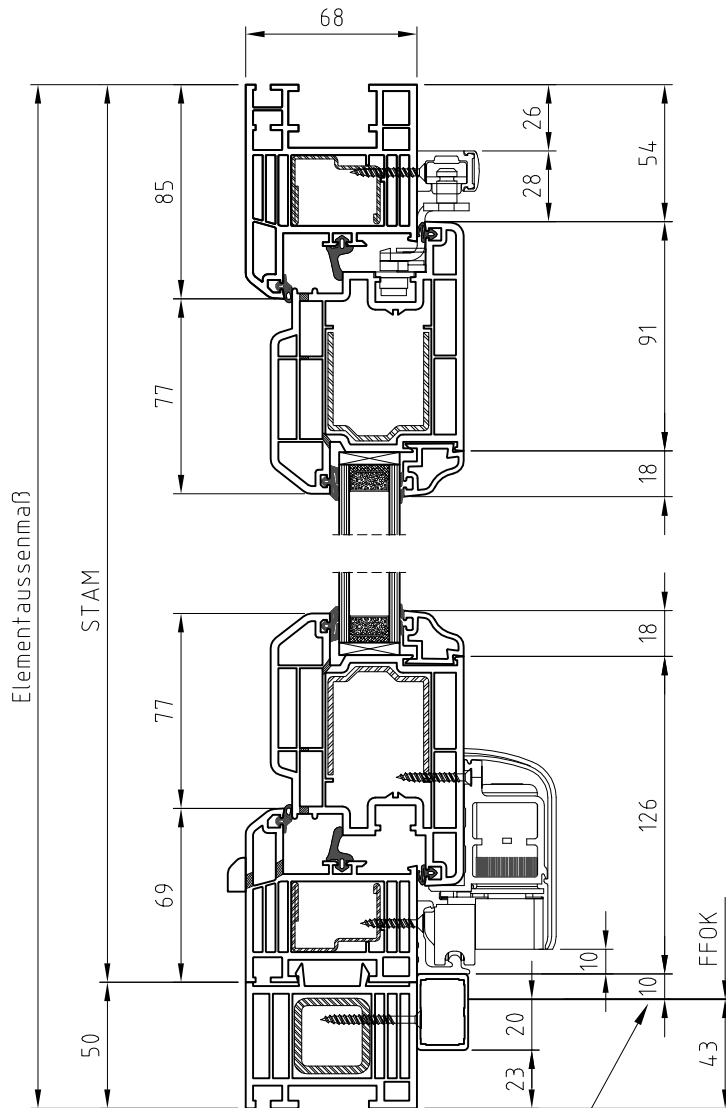

10mm wegen Flügelmontage zwingend einzuhalten

Schnitt waagrecht L-M

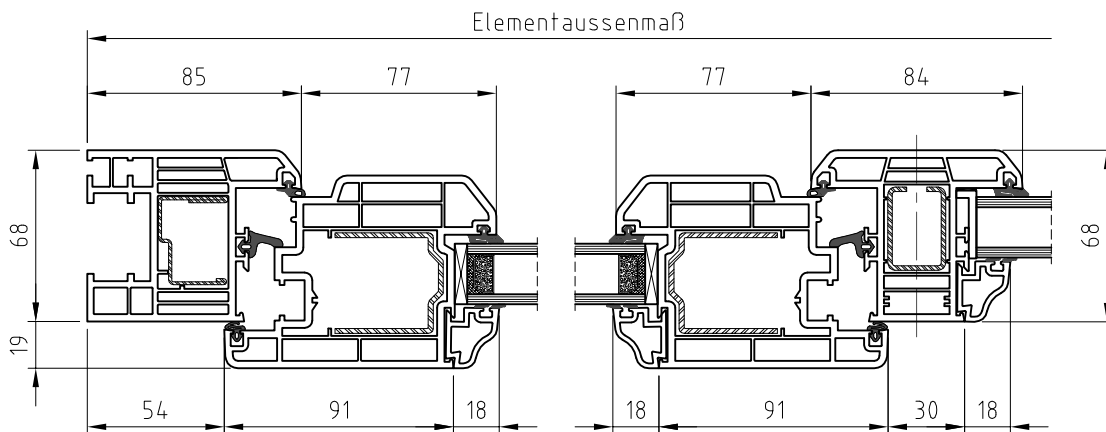

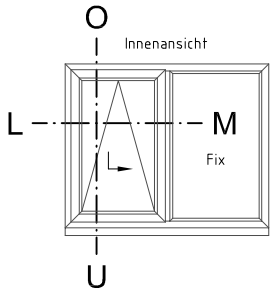
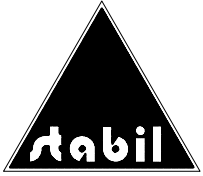

Schnitt senkrecht O-U

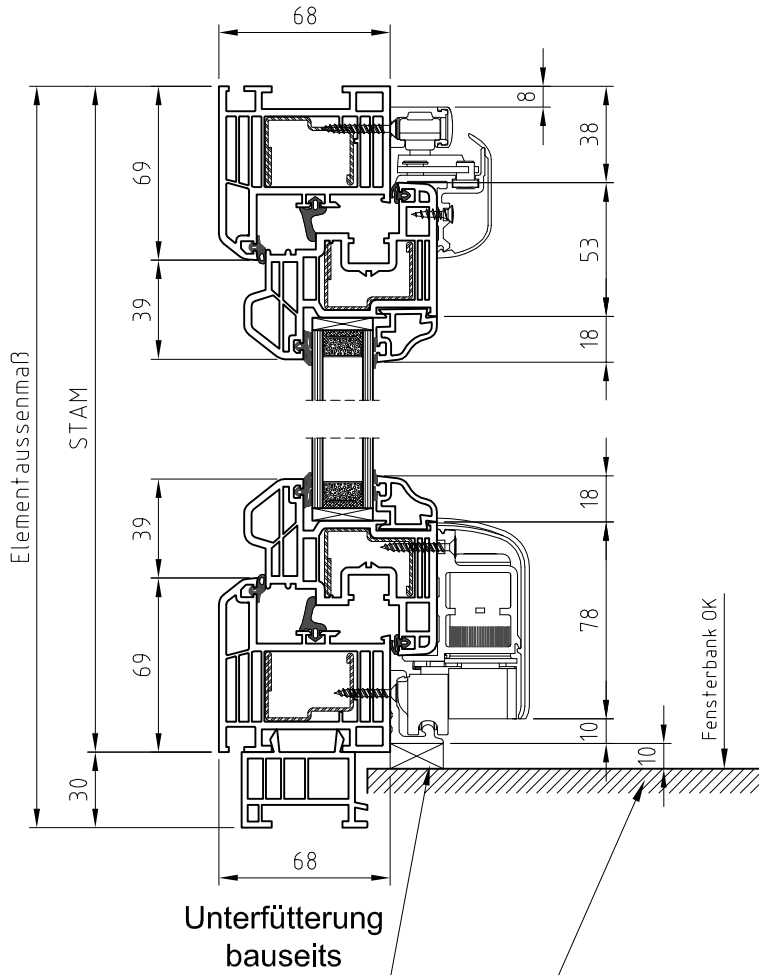

10mm wegen Flügelmontage zwingend einzuhalten

Schnitt waagrecht L-M

